

Room Divider/Cubicle/ Shower Rail Systems

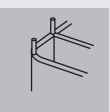



Shower Rail System

Silent Gliss® 1085

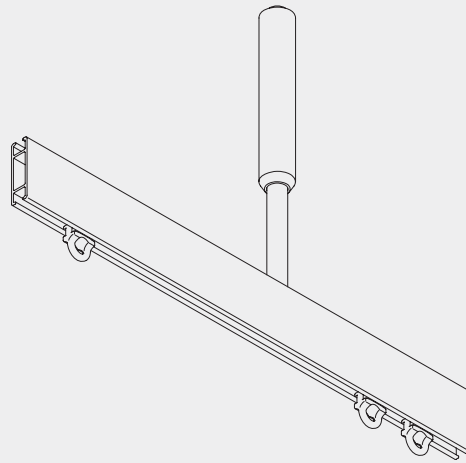

Product Information

- For use as a shower rail only, not suitable for room divider/cubicle
- Attractive reversible rail with varied fixing possibilities
- For medium weight curtains
- Wide application for showers
- Available as a shower rail in kits
- Satin silver anodised finish only
- 4m lengths only



1085

Profile, Bending and Specification Information

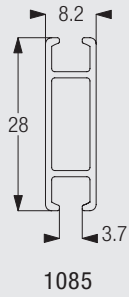

Standard radius 200mm.

The standard radius is recommended for optimal operation. The minimum possible radius is 150mm.

Specification Guide - download from www.silentgliss.co.uk (password required).

Silent Gliss 1085 room divider system, anodised aluminium rail type 1085, secured to fittings detailed as follows. Allow for noggins in suspended ceiling / hollow partitions elsewhere in B of Q. Pre-forming bend in running length 90/135 degrees. Nylon glider/hook 3533C fitted to track at 10/ metre. Nylon wall support 3652 screwed/plugged and screwed to wall and fitted to track using endstop 3017. 3610S hanger rod system, anodised aluminium, drop m once screwed through ceiling to noggin above and secured to track with 3699 insert.

System Layout Options

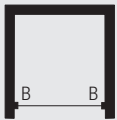
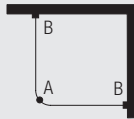
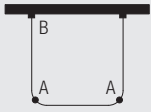

A: hanger rod 3610S
B: wall support 3652



For straight applications hanger rods are not necessary except for extra strength on lengths above 6'/183cm. For pre-packed kits, refer to application chart.

1085

Fitting Options

Ceiling fix with hanger rod 3610S

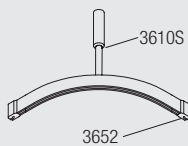
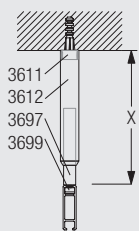

	X (m)
3610S	1.22

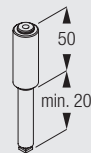

3610S
Hanger rod assembly

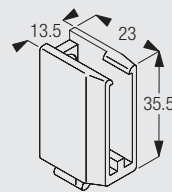

3652
Wall support

Wall fix with wall support 3652

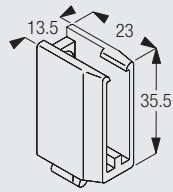
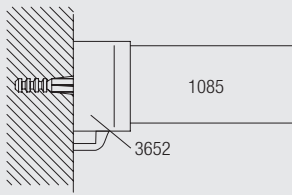





3652
Wall support

Standard Accessories

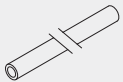
1085	Profile		3017	Endstop	
3652	Wall support		3533C	Glider with hook	

Standard Accessories - Sets

3610S	Hanger rod assembly	3697	Rod	1	
		3698	Washer	1	
		3611	Stud	1	
		3612	Support with screw	1	
		3699	Track insert	1	

1085

Optional Accessories

3070	Twist eye endstop		3071	Screw twist endstop	
3533	Glider		3534	Glider 3533 in strip form	
3570	Rotating glider		6146	Hook	

Useful Information

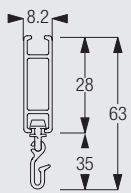

Diagram uses standard glider/hook combination 3533C. For glider 3570 the lower dimension will be 5.4mm.



1085



1085

www.silentgliss.co.uk

www.silentglissglobal.com

Silent Gliss Ltd
Pyramid Business Park
Poorhole Lane
Broadstairs
Kent
CT10 2PT
Great Britain

Tel: +44 (0) 1843 863571
Fax: +44 (0) 1843 864503
info@silentgliss.co.uk

Silent Gliss Global Ltd
Pyramid Business Park
Poorhole Lane
Broadstairs
Kent
CT10 2PT
Great Britain

Tel: +44 (0) 1843 874250
Fax: +44 (0) 1843 874457
info@silentglissglobal.com